

Specification - All in one Dali Emergency Spot

Revision 1



Product Information

Model No.	RSEM/DL
Power Consumption(±5%)/Lumen	3w/240lm
Input Voltage	220-240 VAC, 50-60Hz
LED Type	Samsung 3535
CCT	5000k
Mode	Non Maintained, Self-test Function as standard
Battery	LifePO4 6.4v 1500mah
Body Material	Polycarbonate
Diffuser Material	Polycarbonate
Colour	White (Black as special order)
Discharge Time	> 3 hours
Lens	Open area and corridor supplied
IP Rating	IP20
Surge protection	.5kv (can withstand voltage AC3750v)
Operating Temperature	0°C ~45°C

Dimensions and Mounting

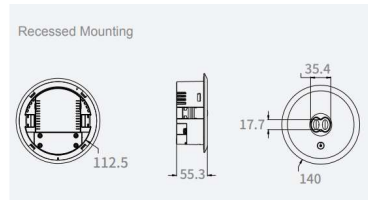
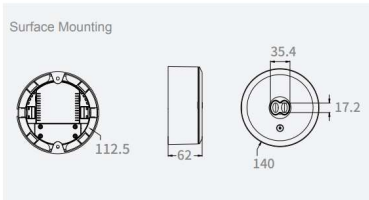

Photometry

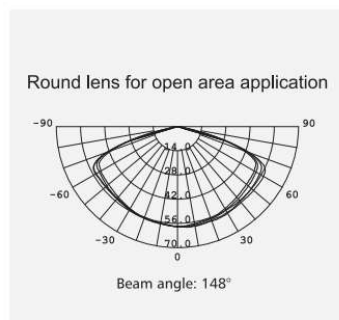
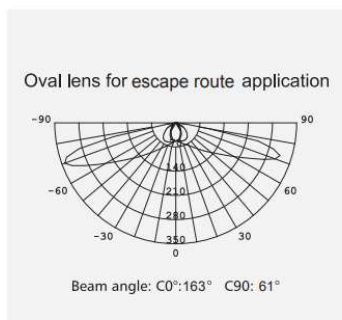

Lifespan and Warranty

Lifetime of LED @ Ta=25°C	> 50,000hrs
Warranty	5 years (3 years for battery)